

ACOMEL



ACO5000 – USER MANUAL

DANAHER MOTION S.A. La Pierreire 2, CH-1029 Villars-Ste-Croix
Telephone +41-21-631 33 33, Telefax +41-21-636 05 09
E-mail: info@danaher-motion.ch
www.danaher-motion.ch

Table of content

Safety instructions	4
Information on the Operating Manual	4
The Basic Safety Rules	4
First read the user manual.....	4
Electric drives are potentially dangerous.....	4
Your qualification	4
Working instruction	5
Over speed protection	5
Overload protection	5
Proper installation	5
Responsibility.....	5
Product description.....	6
Highlights	6
Power supply module	6
External braking resistor module	6
Power Drive module	6
Power ratings.....	6
General technical data	7
Examples of product configuration and weight.....	7
Mounting and installation	8
Mechanical dimensions	8
Description and connection	9
Power terminals.....	9
Input specifications	9
Output specification	9
How to unlock the power terminals.....	10
Power terminal coding.....	10
Front panel description.....	11
Power supply module	11
Power Drive module	11
Control terminals description	11
Control terminals description	12
Sensor input.....	13
7 Segments display	13
Codification of failure.....	14
DECLARATION OF CONFORMITY	15
Assistance and Trouble shooting.....	15

CAUTION



DO NOT INSTALL THE WINDOW PROGRAMMING SOFTWARE BEFORE TO INSTALL THE USB PORT CONNECTION AND DRIVER.

FOLLOW THE INSTRUCTION OF THE INSTALLATION CARD DELIVERED WITH THE WINDOWS SOFTWARE.

Safety instructions

Information on the Operating Manual

This operating manual applies to the ACO5000 frequency inverter family. It describes the connections and basic functions of the standard models.



CAUTION! Danger of death by electrocution



CAUTION! Absolutely essential



Be careful! Incorrect operation, may lead to damage.

The Basic Safety Rules

First read the user manual



Before installing and commissioning, it is important for such personal to read carefully the operating instructions and safety warnings.

Electric drives are potentially dangerous

- Electrical voltages > 230 V/460 V
- High voltages may still be present up to 5 minutes after the power has been cut off. Therefore you must always check for presence of power and voltages!
- In STOP mode, the drive remains active and the motor terminals are at a potential of 300 VDC against the ground.
- Rotating parts
- Hot surfaces



Your qualification

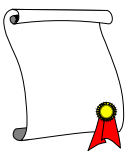

- In order to prevent personal injury and damage to property, only personnel with electrical engineering qualifications may work on the device.
- According to IEC364, DIN VDE0100, the qualified personnel must be familiar with the User Manual
- Have knowledge of national standards and accident prevention regulations

Working instruction

During installation observe the following instructions:

- Always comply with the connection conditions and technical specifications.
- Comply with the standards for electrical installations, such as regarding wire gauges, grounding lead and ground connections.
- Without prior writing agreement** you are not allowed to open the drive. If you do it, the warranty will be void.

Over speed protection

If an over speed protection is required, it must be provided by the motor manufacturer, as this function is not integrated in the drive.

Overload protection

The drive doesn't integrate any input line overload protection. An external overload protection is required for the AC main and the supplied 24 VDC.



Proper installation



Inverter drives are components that are intended for installation within electrical systems or machines. The inverter may not be commissioned or put into operation until it has been established that the machine as a unit complies with the provisions of the EC Machinery Directive (89/392/EEC) as well with the standard EN 60204 (Safety of machines).

If the frequency inverter is used for special applications the specific standards and regulations for this environment must always be observed.

Repairs may only be carried out by authorized repair workshops. Unauthorized opening and incorrect intervention could lead to physical injury or material damage. The warranty provided by DANAHER-MOTION would thereby be void.

If you have to do it, bear in mind that the converter control board uses a large number of MOS (Metal Oxide Semiconductor), which are highly sensitive to electrostatic charge.

To avoid any damages to the control board:

- make sure you are working on an earthen anti-static floor
- use anti-static packing material only

Responsibility



Electronic devices are fundamentally not fail-safe. The company setting up and/or operating the machine or plant is itself responsible for ensuring that the drive is rendered safe if the device fails.

The standard EN 60204-1/DIN VDE 0113 "Safety of machines", in the section on "Electrical equipment of machines", stipulates safety requirements for electrical controls. The requirements to comply with are intended to protect the integrity of personnel and machines and to maintain the function capability of the machine or plant. The function of an emergency off system does not necessarily have to cut the power supply to the drive.

To protect against risk of injury, it may be more beneficial to maintain individual drives in operation or to initiate specific safety sequences. The emergency stop process may be assessed by means of a risk analysis of the machine or plant, including the electrical equipment to EN 1050. Part of this analysis is determined by the selection of the circuit category in accordance with EN 954 "Safety of machines – Safety related parts of controls".

We strongly suggest the use of the provided certified safety relay in accordance with the EN954-1 recommendations (see paragraph "Control terminals description").

Product description

Highlights

- PAM – Pulse Amplitude Modulation – a technology with regulated intermediate DC bus
- Traditional ACOMEL SHS – Selective Harmonic Suppression – modulation
- Windows based programming software
- Can be operated via Terminal Block, dedicated KeyPad KP5, CAN or Profibus
- Large number of free programmable parameters
- 32 complete sets of motor parameters can be stored and selected
- CE and UL (pending)

Power supply module

- Input voltage 200 – 480 VAC, +10% / -15%, 50/60 Hz, auto-ranging
- DC power output max. 36 A
- Power IN connect to the bottom
- Integrated dynamic braking resistor, 330 Ω /1000 W peak
- Possibility to add an external braking resistor module
- 24 VDC, auxiliary power input supplied by customer, 2 to 4 A depending of the number of axis
- CAN port, internally interconnected to the drive(s)
- USB port, internally interconnected to the drive(s)
- RS485 port dedicated to remote KeyPad
- Article designation: ACO5000A

External braking resistor module

- Same dimensions as the power supply module
- Internal connection to the power supply module
- Used when full braking power is required
- Rating 22 Ω / 1200 W (5 kW peak)
- Article designation: ACO5000R

Power Drive module

- Internal connections to the power supply module
- Motor power OUT and PTC input connect to the bottom
- Pluggable screw terminals – see "Control terminals description"
- All "Control terminals" are opto-insulated
- CAN port
- PROFIBUS port (Option)
- Sensor feedback connector (not compulsory to drive a motor)
- 7 segments status display
- 4 power ratings: 5, 8, 12 and 20 A, 2 physical sizes
- Max output frequency 5000 Hz
- Article designation: ACO50xxD (see "Power ratings" table)

Power ratings

Drive	Nominal current	Peak current	Max output Power @ 230 V	Max. Output Power @ 400 VAC	Max. power dissipation
ACO5005D	5 A	7.5 A	3 kVA	5 kVA	200 W
ACO5008D	8 A	12 A	5 kVA	8 kVA	320 W
ACO5012D	12 A	18 A	7 kVA	12 kVA	480 W
ACO5020D	20 A	30 A	12 kVA	20 kVA	800 W

General technical data

	Unit	Comment
Output frequency step	Hz	≤ ± 0.5‰ of the set frequency
Type of load		Resistive / Inductive
Short-circuit protection between phases		At terminals
Ground short-circuit protection		At power ON and at terminals
Efficiency at nominal load	%	96
Max. ambient temperature	°C	40
Output power derating relative to the operating altitude		> 1000 m, derating of 5% per 1000 m. Max. operating altitude 2000 m – derating 10%
Output power derating relative to the operating ambient temperature	%/°C	3% / °C over the ambient of 40°C Max. ambient temperature 50° C
Relative humidity	%	15 ... 85 not condensing
Storage temperature	°C	-25 to +55 according VDE0160
Shipping temperature	°C	-25 to +70 according VDE0160

Examples of product configuration and weight

Designation	ACO 5000A	ACO 5005D	ACO 5008D	ACO 5012D	ACO 5020D	ACO 5000R	Size	Weight kg
SINGLE AXIS								
ACO5-0005T	1	1					2	11.5
ACO5-0005R	1	1				1	3	13.8
ACO5-0008T	1		1				2	11.5
ACO5-0008R	1		1			1	3	13.8
ACO5-0012T	1			1			3	18.6
ACO5-0012R	1			1		1	4	20.7
ACO5-0020T	1				1		3	18.6
ACO5-0020R	1				1	1	4	20.7
MULTI-AXIS								
ACO5-0055T	1	2					3	16.9
ACO5-0055R	1	2				1	4	19.2
ACO5-0085T	1	1	1				3	16.9
ACO5-5555T	1	4					5	27.6
ACO5-5555R	1	4				1	6	29.9
ACO5-0888R	1		3			1	5	24.5
ACO5-1255T	1	2		1			5	26.7
ACO5-1285R	1	1	1	1		1	6	29.0
ACO5-1212R	1			2		1	6	33.3
Any configuration up to size 6 (6 modules units) so far at any time, the sum of the currents doesn't exceed 36A as peak power. Any configuration exceeding the max. is not allowed, the power supply being not protected for overload. Only the drive(s) integrated a current limitation and an overload protection.								

Mounting and installation

Mechanical dimensions

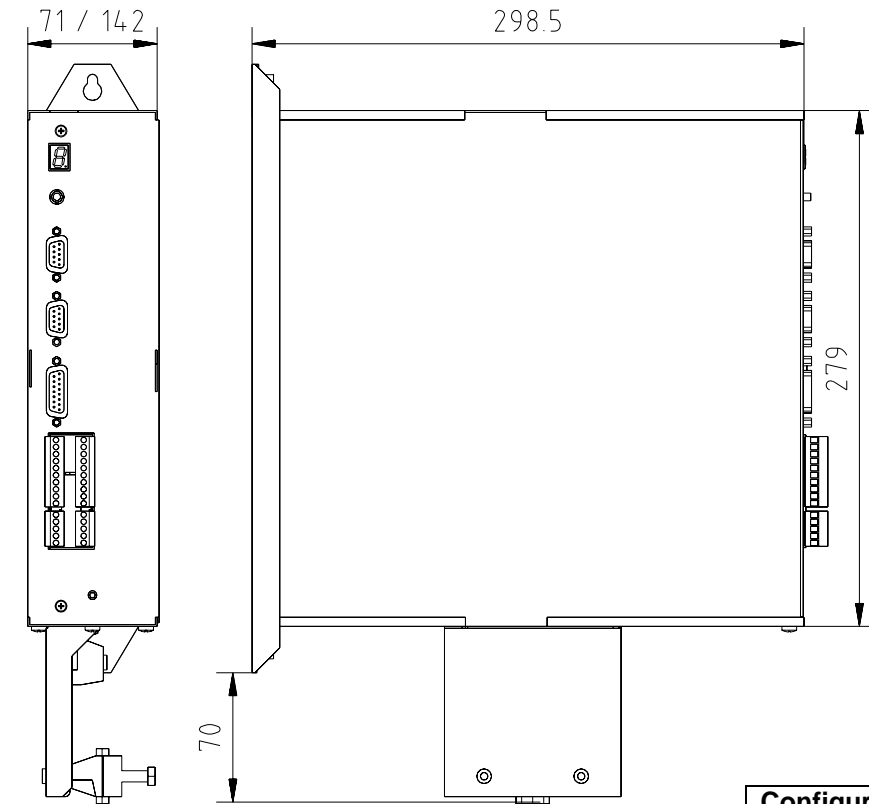

Module dimensions

- ACO5000A
- ACO5000R
- ACO5005D
- ACO5008D
 - Width 71 mm
- ACO5012D
- ACO5020D
 - Width 142 mm
- Mounting position vertical
- Cabinet integration: For proper cooling leave 10 cm free space on top of the inverter.

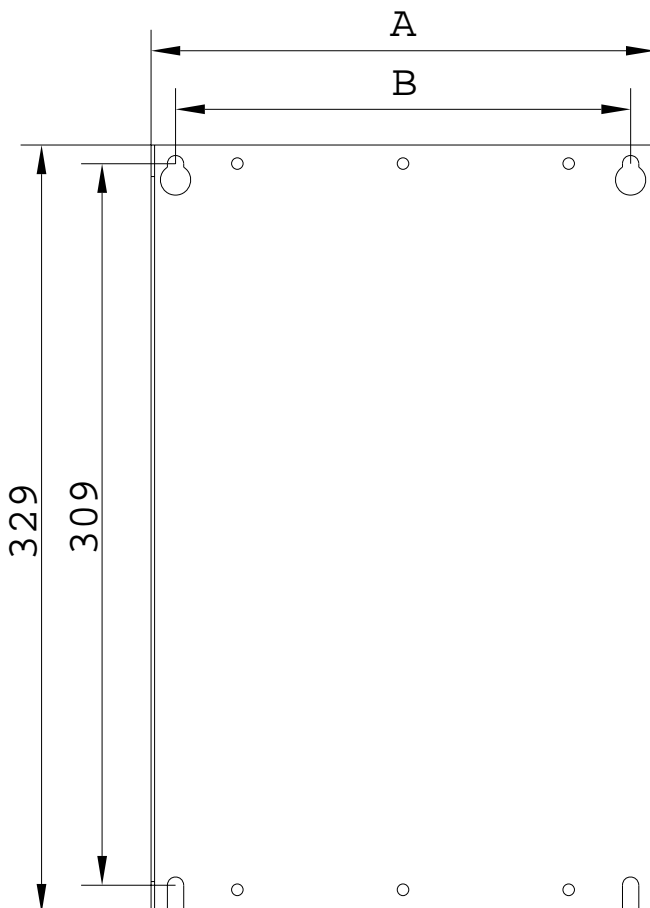

Configuration	A	B
"2 modules unit" made of: <ul style="list-style-type: none"> ▪ 1 ACO5000A ▪ 1 ACO5005D / 08D 	145	124
"3 modules unit" made of: <ul style="list-style-type: none"> ▪ one of the above and 1 ACO5000R, or 1 ACO5000A and 2 ACO5005D / 08D, or 1 ACO5000A, and 1 ACO5012D / 20D 	216	195
"4 modules unit" made of: <ul style="list-style-type: none"> ▪ any combination of 1 ACO5000A, drive(s) ACO50xxD and/or 1 ACO5000R 	287	266
"5 modules unit" made of: <ul style="list-style-type: none"> ▪ any combination of 1 ACO5000A, drive(s) ACO50xxD and/or 1 ACO5000R 	358	337
"6 modules unit" made of: <ul style="list-style-type: none"> ▪ any combination of 1 ACO5000A, drive(s) ACO50xxD and/or 1 ACO5000R 	429	408
Mounting screws: 4 x M6		
NOTE: At any time, the sum of the current of any drive combination must not exceed 36A as peak power.		

Description and connection

Power terminals

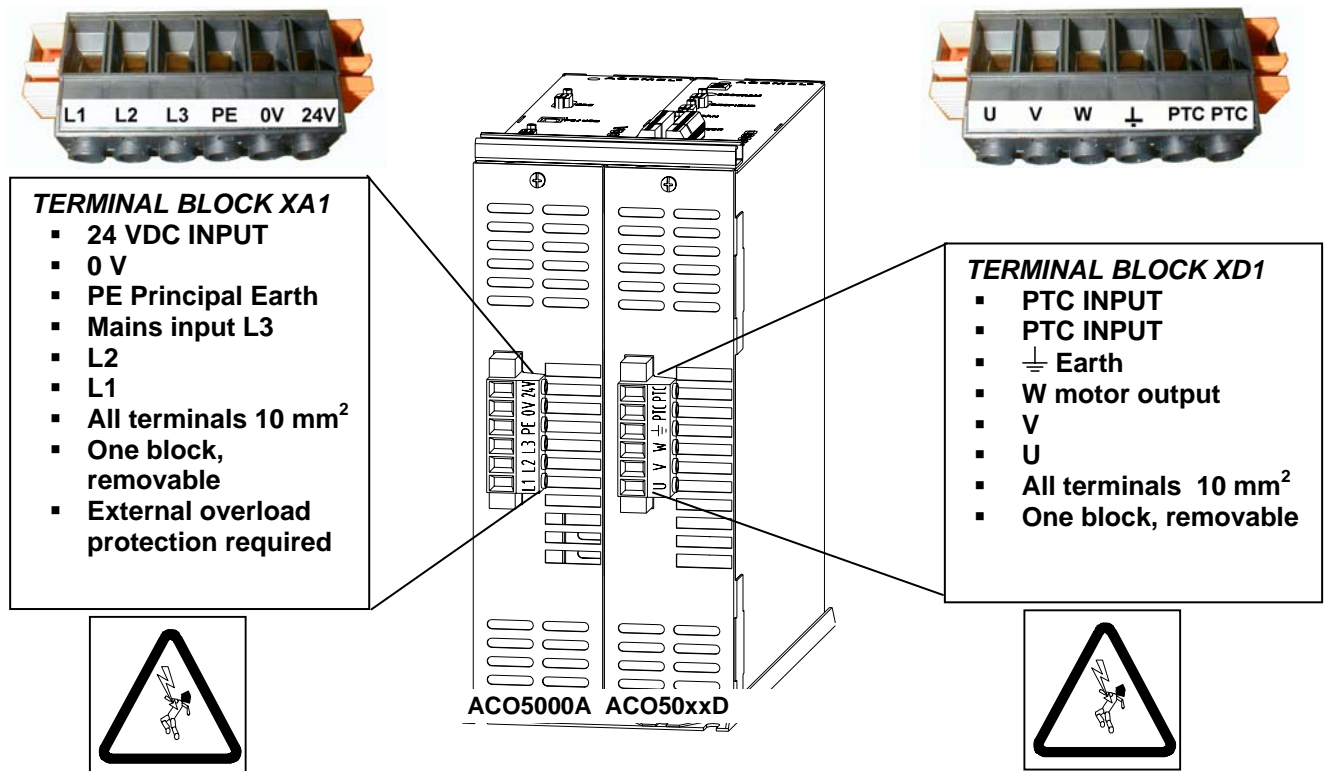

Input specifications

- AC line
 - Input voltage
 - min. 200 V single phase -15%
 - max. 3 phases 480 V
 - 50 / 60 Hz
 - Single phase input connect to any 2 of L1, L2 or L3
 - External overload protection (fuse) required, max. 32 A
 - Use copper conductors 75°C
- 24 VDC power supply
 - Voltage tolerances $\pm 10\%$
 - Required power min. 1 A per module
 - External overload protection required if not short-circuit proof

Output specification

- Motor power
 - Use power cable according to the recommendation of the motor manufacturer
 - Cable gauge according the motor current requirements
- PTC input
 - This input is over voltage proof up to 500 VAC
 - In case of use of temperature sensor, program the appropriate input calibration.

How to unlock the power terminals

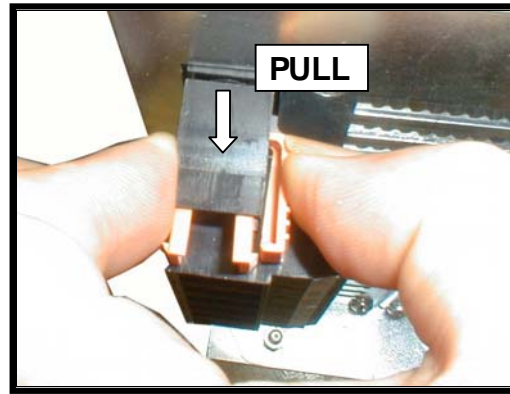
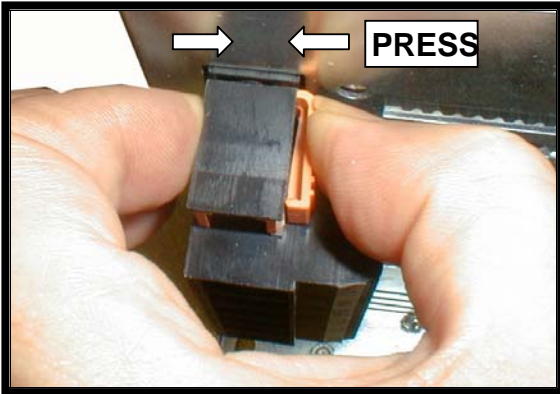

Power terminal coding

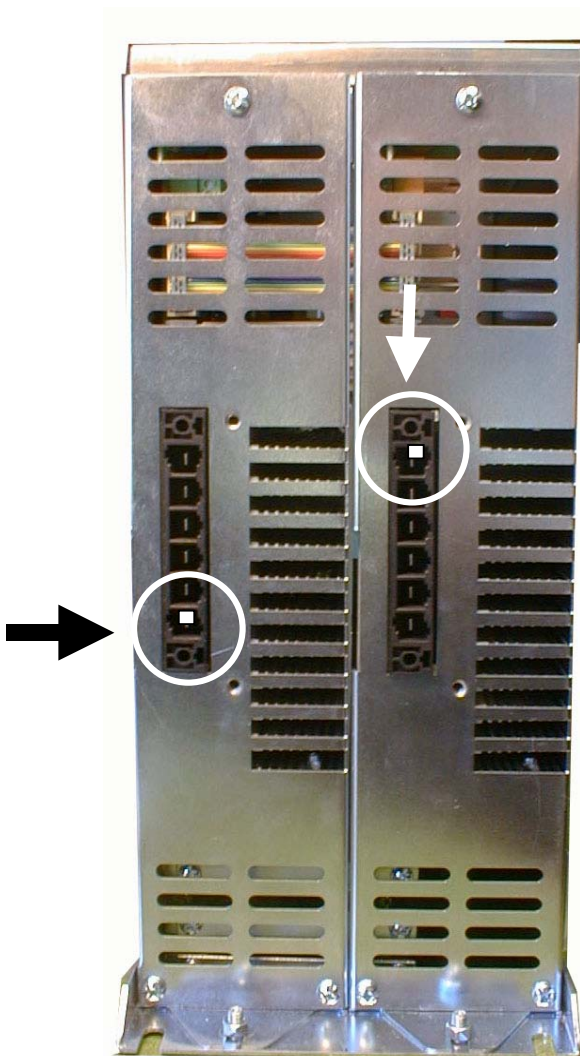

To avoid the risk of inverting the connectors of the power supply and the drive(s), both connectors are coded. The pictures show the coding position (white square) and the way to insert the coding tag (the right pictures show a half inserted tag).

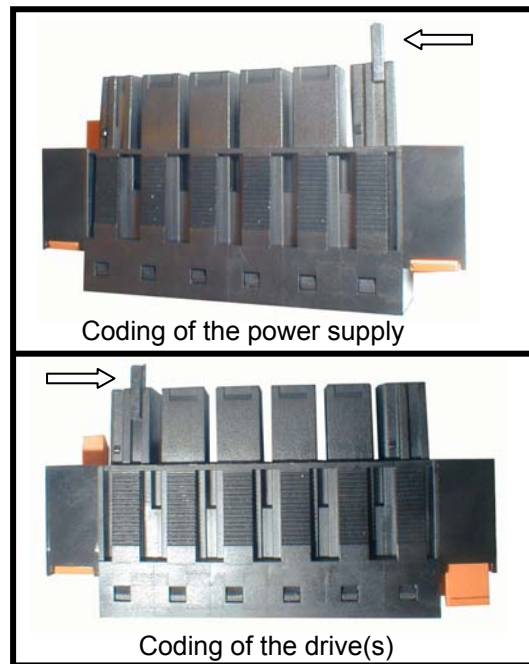

Front panel description

Power supply module

D-sub 9 poles connector for the specific user interface. This **option** is currently under design and will be available Q2/2005

USB Port dedicated as service port to:

- Program the drive(s)
- Up-date the firmware
- Commission the installation
- Testing and debugging
- Internally connected to the drive(s)

Note: Not to be used to operate the equipment in production.

CAN Port IN
 This field bus is currently under design and will be available in 2005.
 This bus is connected internally to the drive(s).

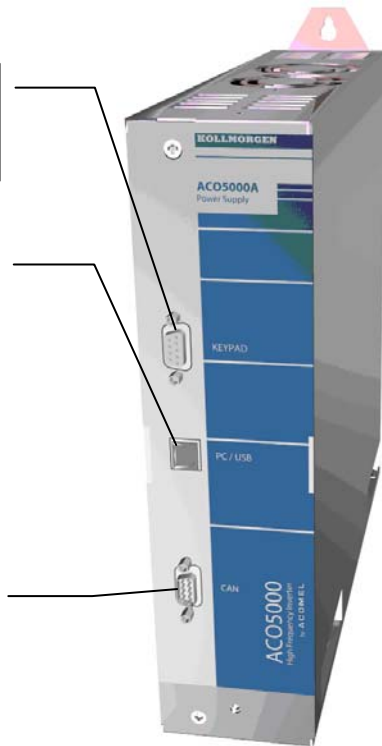

Power Drive module

7-segments display shows the current status of drive, used as fault indicator too.

PROGRAM: a service **push button** used to upgrade the firmware via the USB port. Pressing this button at power ON or under power for more than 5 sec will initiate a point-to-point connection. This port is used to set the # of the drive(s) and their CAN or PROFIBUS adress.

PROFIBUS D-sub 9 poles connector. This **option** is currently under design and a limited version will be available end of Q1 / 2005. This fieldbus is an option, not to be retrofit in the field. Ask for the specific user manual.

CAN Port - this field bus is currently under design and will be available in 2005. This bus is connected internally to the drive(s). Ask for the specific user manual.

SENSOR input for speed feedback. TTL encoder or magneto-resistive sensor

Removable **CONTROL TERMINALS**
 See "Control terminals description"

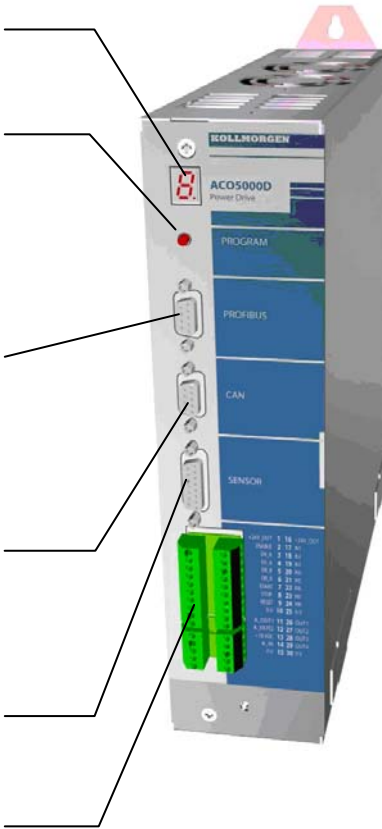

Control terminals description

NOTE: All digital and analogue inputs and outputs are opto-isolated. All outputs are short-circuit proof.

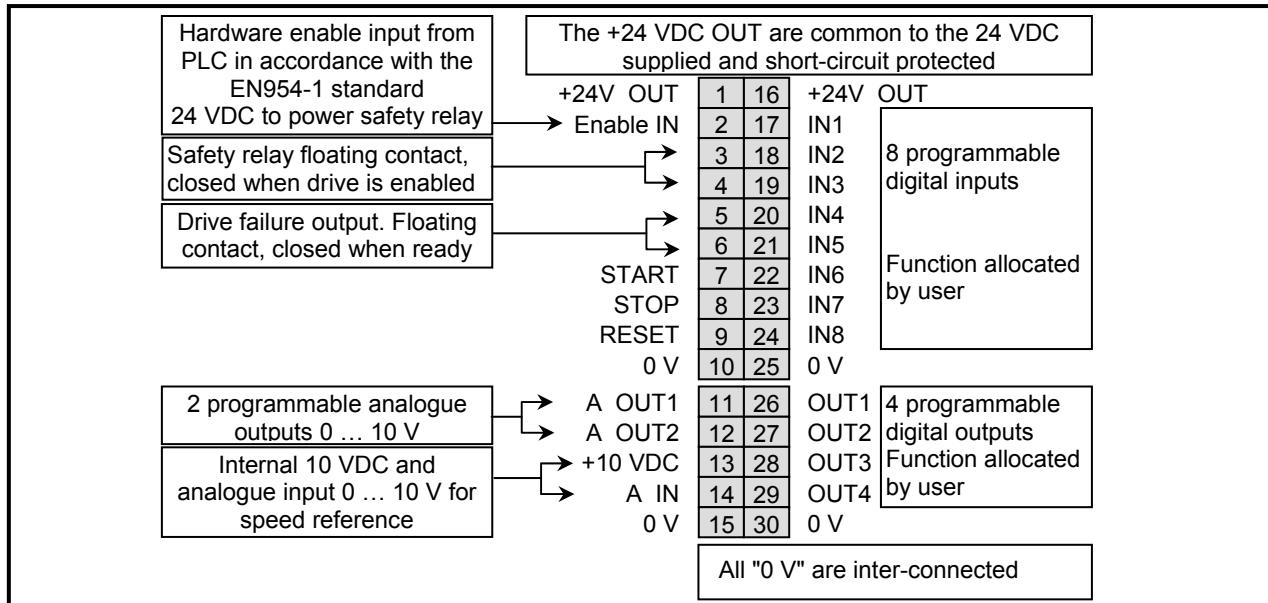

#	Name	DESCRIPTION
1	24V_OUT	Same potential as the external supplied 24 VDC. Available to activate an input. This output is short circuit protected.
First terminal bloc section X1-1	2	ENABLE This enable is given by the CNC or PLC once all START conditions are satisfied. Without this enable, a START is impossible as the drivers of the chopper and the output stage are locked. Apply 24 VDC to energise the safety relay. Note: If this function is not managed by the CNC or PLC, a jumper must be put between terminals X1-1/1 and X1-1/2. If the AC power is not applied to the drive when the "enable" is powered, an error message will be displayed. A RESET is then needed before to start.
	3	EN_A This NO relay contact will close when the "enable" is powered. This information has normally to be sent back to the CNC or PLC as status confirmation.
	4	EN_A This relay contact is potential free. Max contact load 230VAC /2A or 24VDC/2A
	5	DR_R This NO relay potential free contact will close when the drive is READY resp. the relay energized, The contact will be open in case of FAILURE.
	6	DR_R Maximal contact load 125VAC/0.6A resp. 30VDC/2A or 110VDC/0.6A
	7	START Apply 24 VDC to START the drive. This function is active only if the drive enable has been powered (X1-1/2). The START can be activated with: <ul style="list-style-type: none"> □ A permanent signal □ An impulse signal, duration min. 5 ms The type of START is selected by program.
	8	STOP The drive will STOP when the 24 VDC is not applied to this input. If you use a permanent signal to START, this input must be connected to 24 VDC by a jumper to terminal X1-1/1 for example. If not, the drive will not start and an error message will be displayed.
	9	RESET Apply 24 VDC to reset. Need always to be done after a failure. Don't apply a permanent 24 VDC as the reset is triggered by the positive edge of the signal. Min. duration of the pulse: 5 ms
	10	0 V Electronic ground of the drive, linked to the 0 V of the external 24 VDC
	X1-2	11
12		A_OUT2
13		+ 10 VDC Available to connect a potentiometer between X1-2/13 and X1-2/15, with the cursor to the input A_IN to make a manual analogue speed reference. Use a 10 kΩ potentiometer.
14		A_IN Analogue speed reference input 0 to 10 V, referred to 0 V – X1-2/15
15		0 V Electronic ground of the drive, linked to the 0 V of the external 24 VDC

	#	Name	DESCRIPTION
X1-3	16	24V_OUT	Same potential as the external supplied 24 VDC. Available to activate an input
	17	IN1	8 programmable digital inputs Function allocated by user All inputs are opto-isolated
	18	IN2	
	19	IN3	
	20	IN4	
	21	IN5	Insulated type 24 VDC VOFF [VDC] -0.3 - 5.0 @ 1 mA (max) VON [VDC] 15 - 30 @ 10 mA (typical)
	22	IN6	
	23	IN7	
	24	IN8	
25	0 V	Electronic ground of the drive, linked to the 0 V of the external 24 VDC	

X1-4	26	OUT1	4 programmable digital outputs, function allocated by user All outputs are opto-isolated, max. load 10 mA, 24 VDC By allocating the output frequency SDIG (6 times the output frequency) to one of these outputs, use a load resistors of max. 3.3 kΩ
	27	OUT2	
	28	OUT3	
	29	OUT4	
	30	0 V	Electronic ground of the drive, linked to the 0 V of the external 24 VDC

Sensor input

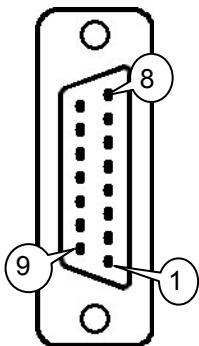















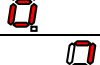

1	Sensor detect +5 VDC	9	RESERVED
2	NA	10	RESERVED
3	RESERVED	11	RESERVED
4	Input magneto-resistive sensor	12	INDEX -
5	INDEX +	13	Channel B -
6	Channel B +	14	Channel A -
7	Channel A +	15	+ 5 VDC power supply sensor
8	Ground 0 V	The case must be connected to earth	

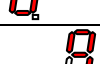
The sensor input accept either 5 V TTL encoder signals or the signal from a magneto-resistive sensor (Siemens – FP210 D 250-22 or FP212 D 250-22)

7 Segments display

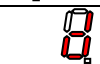
	The drive is in STOP mode
	START mode: the segment is rotating clockwise or counter-clockwise according to the direction of the rotation of the motor
	E flashing indicates a failure. The display will show alternatively an "E" and an alphanumeric character indicating the type of failure. For detail see paragraph "Codification of failure"
	Indicate that the DC current braking is active (FCC)
	Indicate that the permanent DC braking current is active (FCP)
	The dot indicates that the serial connection via USB port is active point-to-point with this drive. This mode is activated by pressing the push button PROGRAM during more than 5 s.

Codification of failure

	Enable not released. This error is displayed when a START is given before the ENABLE has been released
	Converter overload.
	Short-circuit to ground
	Over voltage on intermediate DC-Bus. Indicate a voltage surge on the DC-bus exceeding 900 DC peak. This peak could come from the mains or back from the motor.
	Power fails. Will be shown when the ENABLE is activated and the AC voltage is missing.
	Auxiliary power supply failures. Indicates that one of the auxiliary voltages ± 15 VDC or 5 VDC is missing.
	External interlock is open
	Motor temperature too high (PTC)
	Motor temperature too high (NTC)
	Klixon contact open. Indicate that the temperature of the external braking resistor is too high or that this external module has been removed and the safety jumper not put in place.
	Motor overload, i.e. $I_m > I_{ref}$
	Regen/Accel: this indicates that the dynamic braking process has been activated during the acceleration. A START was probably activated when the motor was still spinning.
	Not allocated
	Not allocated
	Not allocated
	Not allocated

DECLARATION OF CONFORMITY

We: **Danaher Motion S.A**
La Pierreire 2
CH - 1029 Villars-Ste-Croix

declare under our sole responsibility that the products of the family **ACO5000**, are exclusively designed for incorporation in an other machine. The operation of the product is submitted to the conformity of the complete equipment, following the provisions of the directive **89/392/EEC**

The conformity of the above specified products with the provisions of the Directive **73/23/EEC** is supported by the respect of the standards **CEI/IEC 1010-1**

If the mounting and connecting instructions of the installation's manual have been respected, this product will be conform to the standards EN 61000-6-4, EN 61000-6-2 and EN61800-3 +A11 relating to the EMC directive **89/336/EEC**.

Mounting instructions related to the EMC - directive 89/336/EEC

1. The frequency converter must be mounted in a closed metal cabinet.
2. The power connection between converter and motor must be made using shield cable.
3. The control connection must utilize shielded cables.
4. The shield of the cables must be grounded at both ends.
5. Power connections and control connection must be placed in separated canals.
6. No external input filter is required.

Assistance and Trouble shooting

All our products are manufactured in accordance with an accurate quality process. Before delivery they are checked for many hours under power. The quality system and production process guarantee that all products are shipped free of default.

The respect of the installation procedure describes in this manual and a correct definition of the application should avoid any commissioning problems.

Should you meet some problems during installation or commissioning of the frequency inverter our technical staff are available for assistance. Please contact your local supplier or the local DANAHER-MOTION subsidiary.

Please includes following information:

1. Description of the application
2. Default or problem you met
3. Copy of the programmed parameters
4. Wiring diagram

In case of emergency: Danaher Motion S.A.
La Pierreire 2
CH - 1029 Villars-Ste-Croix

Tel. +41 21 631 33 33
Fax. +41 21 636 05 09
E-mail: info@danaher-motion.ch

NOTE: This user manual is subject to modification without prior notice.



MANUAL ACO5000_GB / printed in Switzerland © 02/2005
Subject to change without prior notice



Danaher Motion SA
La Pierreire 2
CH-1029 Villars-Ste-Croix
Switzerland
Tel +41 (0) 21 631 33 33
Fax +41 (0) 21 636 05 09
E-mail info@danaher-motion.ch
Internet www.DanaherMotion.net